

HEART™

Product Description Assembly Manual

Part No. 620293B

Revised February 25, 2009



TRINITY
HIGHWAY PRODUCTS
ENERGY ABSORPTION SYSTEMS



2525 Stemmons Freeway
Dallas, Texas 75207



IMPORTANT: These instructions are to be used only in conjunction with the installation/repair of the Hybrid Energy Absorbing Reusable Terminal (“HEART”). These instructions are for standard installations specified by the appropriate highway authority only. In the event the specified system installation/repair requires or involves special circumstances, contact the appropriate highway authority engineer. A Trinity Highway Products, LLC representative is available for consultation if required.

This Manual must be made be available to the worker at all times. For additional copies, contact Trinity Highway Products, LLC. at 800-527-6050.

The instructions in this Manual supersede all previous versions. All information, illustrations, and specifications in this Manual are based on the latest HEART information available at the time of printing. We reserve the right to make changes at any time.

TABLE OF CONTENTS

TABLE OF CONTENTS.....	2
CUSTOMER SERVICE CONTACTS.....	3
SUGGESTED SAFETY RULES – FOR INSTALLATION	3
SAFETY SYMBOLS.....	3
GENERAL INFORMATION	6
HEART SPECIFICATIONS	6
KNOW YOUR HEART	7
Bill Of Material.....	8
SHOP HARDWARE	9
HEART INSTALLATION INSTRUCTIONS	10
SUGGESTED TOOL LIST	10
SAFETY INSTRUCTIONS	10
SITE PREPARATION	10
LIFTING AND ALIGNING INSTALLATION INSTRUCTIONS	11
ANCHORING INSTALLATION INSTRUCTIONS.....	12
INSTALLATION OF THE HEART WITH BACKUP STRUCTURE.....	14
UNI-DIRECTIONAL INSTALLATION.....	14
UNI-DIRECTIONAL/RIGID OBJECT INSTALLATION	14
Option 1: USE OF BACKUP STRUCTURE	14
Option 2: USE OF BRACKETS	14
RESTRAINING PRE-CAST BARRIER.....	18
BI-DIRECTIONAL INSTALLATION.....	19
BI-DIRECTIONAL/PERMANENT BARRIER INSTALLATION.....	19
BI-DIRECTIONAL/PRE-CAST CONCRETE BARRIER INSTALLATION	20
DELINEATION	20
DELINEATION	20
HEART REPAIR INSTRUCTIONS	21
SUGGESTED TOOL LIST	21
SAFETY INSTRUCTIONS	21
MAJOR COMPONENTS OF THE HEART.....	22
REPAIRING HEAD/ANGLE IMPACT ON THE NOSE	22
REPAIRING DAMAGED NOSE SECTION	23
REPAIRING SIDE IMPACT	24
REPLACING A DIAPHRAGM 1 OR 2.....	24
REPLACING A DIAPHRAGM (3 THROUGH 9).....	27
REPLACING TRANSITION PANEL.....	29
SIDE PANEL REPAIR.....	29
REPLACING ANCHOR BOLTS/RODS	30
APPENDIX DRAWINGS	31
Plan, Elevation, & Section Shop Assembly Details PN 26073 Unidirectional – E1 of E2.....	1501/PN26073 31
Plan, Elevation, & Section Shop Assembly Details PN 26073 – E2 of E2.....	1501/PN26073 31
Plan, Elevation, & Sections Unidirectional; Field Placement.....	SS 1502..... 31
Type F Concrete Median Barrier Plan, Elevation & Sections.....	SS 1506..... 31
Concrete Median Barrier Plan, Elevation, & Sections Unidirectional Traffic Only.....	SS 1507 31
Unidirectional & Bidirectional Traffic Flows HDPE Side Panel Lapping Schematic.....	SS 1508 31

CUSTOMER SERVICE CONTACTS

Trinity Highway Products, LLC. is committed to the highest level of customer service. Feedback regarding the HEART system, their installation procedures, supporting documentation, and performance is always welcome. Our goal is to enhance highway safety through innovation. Additional information can be obtained by calling the telephone numbers below:

TRINITY HIGHWAY PRODUCTS, LLC.:	
Telephone:	800-879-8000 (U.S. Calls) 214-589-8140 (International Calls)
Fax:	214-589-8423
E-mail:	product.info@trin.net
Internet:	www.highwayguardrail.com
REGIONAL TELEPHONE CONTACTS:	
Centerville, Utah	800-772-7976
Dallas, Texas	800-527-6050
Elizabethtown, Kentucky	800-282-7668
Girard, Ohio	800-321-2755
Orangeburg, South Carolina	800-835-9307
International	214-589-8140
Canada	800-835-6051



SUGGESTED SAFETY RULES – FOR INSTALLATION

* IMPORTANT SAFETY INSTRUCTIONS *













Always keep this Manual in a location where it is easily accessed by persons who install/repair the HEART. Additional copies of this Manual are available from Trinity Highway Products, 800-527-6050. Please contact Trinity Highway Products if you have any questions concerning the information in this Manual or about the HEART.



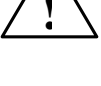





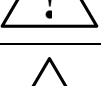
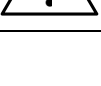

SAFETY SYMBOLS

This Manual describes safety symbols and pictographs that may appear on the HEART. Read the Manual for complete safety, assembly, operating, maintenance, repair, and service information.

SYMBOL	MEANING
	<ul style="list-style-type: none"> ▪ SAFETY ALERT SYMBOL <p>Indicates Danger, Warning or Caution. Failure to read and follow the Danger, Warning, and Safety or Caution indicators could result in serious injury or death to the workers and/or bystanders.</p>
	<ul style="list-style-type: none"> ▪ WARNING – READ MANUAL <p>Read the Manual and follow all warnings and safety instructions. Failure to follow this warning could result in serious injury or death to the workers and/or bystanders.</p>

READ ALL INSTRUCTIONS BEFORE INSTALLING/REPAIRING

	IMPORTANT: READ SAFETY INSTRUCTIONS THOROUGHLY AND FOLLOW THE SUGGESTED SAFE PRACTICES BEFORE INSTALLING/REPAIRING THE HEART. Failure to follow this warning can result in serious injury or death to the worker and/or bystanders. Please keep these instructions for later use.	
	WARNING: Read the instructions carefully. Be familiar with the complete instructions for the HEART before installing/repairing the HEART. Failure to follow this warning could result in serious injury or death in the event of a collision.	
	WARNING: Ensure that the necessary traffic control is setup before beginning the installation/repair. Failure to follow this warning could result in serious injury or death in the event of a collision.	
	WARNING: Be sure adequate time is available for complete installation/repair before beginning the installation/repair process. Failure to follow this warning could result in serious injury or death in the event of a collision.	
	WARNING: When lifting or moving the HEART maintain control of the unit by guiding the end with a guide rope. Failure to follow this warning could result in serious injury or death.	
	WARNING: Do NOT perform installation, maintenance, or repair of the HEART when tired, ill, or under the influence of alcohol, drugs, or medication. Failure to follow this warning could result in serious injury or death to the workers and/or bystanders in the event of a collision with the HEART.	
	WARNING: Do not install, maintain, or repair the HEART until you have read and understand this Manual thoroughly. Please call Trinity Highway Products, LLC. at 800-664-7976 if you do not understand the installation instructions. Failure to follow this warning could result in serious injury or death to the workers and/or bystanders in the event of a collision with the HEART.	
	WARNING: Use only Trinity Highway Products' parts for installing/repairing the HEART. The installation/repair of unauthorized accessories is strictly prohibited. Failure to follow this warning could result in serious injury or death in the event of a vehicle impact with a NON-APPROVED system.	
	WARNING: Do NOT modify the HEART in any way. Failure to follow this warning could result in serious injury or death in the event of a collision.	
	WARNING: Do NOT perform installation/repair if the HEART site, shoulder, or traveled area are covered or encroached by road debris. Failure to follow this warning could result in serious injury or death in the event of a collision.	
	WARNING: Safety measures incorporating traffic control devices must be used to provide safety for personnel while at the installation/repair site. Failure to follow this warning could result in serious injury or death to the workers and/or bystanders.	
	WARNING: Ensure that the entire work zone site is visible at all times. Failure to follow this warning could result in serious injury or death to the workers and/or bystanders.	
	WARNING: Use caution when working near public roads. Be mindful of vehicles in motion nearby. Failure to follow this warning could result in serious injury or death to the workers and/or bystanders.	
	WARNING: Ensure that the HEART and delineation used meet all federal, state/specifying agency, and local specifications. Failure to follow this warning could result in serious injury or death in the event of a collision.	

	WARNING: Ensure that your installation meets all appropriate Manual on Uniform Traffic Control Devices (MUTCD) and local standards. Failure to follow this warning could result in serious injury or death in the event of a collision.
	WARNING: Ensure that there is proper site grading for HEART placement as dictated by the state/specifying agency, pursuant to FHWA acceptance. Failure to follow this warning could result in serious injury or death in the event of a collision.
	WARNING: Ensure that the grading leading up to the HEART and around the system is flat so that the vehicle will not be in an erratic motion before impact. To prevent this, the cross slope should be no more than 12:1 and the HEART system should not be placed directly behind a raised curb. Failure to follow this warning could result in serious injury or death in the event of a collision.
	WARNING: Do NOT attempt to move the HEART without attaching it to a forklift or boom truck (with a 4,000 lbs capacity). The HEART system weighs up to 2,700 lbs when fully assembled. Failure to follow this warning could result in serious injury or death to the workers and/or bystanders.
	WARNING: If the unit can be impacted from the reverse direction, an appropriate transition will be required. The unit should be aligned so the transition pieces do not create a snagging point where they are connected to the HEART. Failure to follow this warning could result in serious injury or death in the event of a collision.
	WARNING: Existing concrete foundations or new concrete foundations must be of the dimensions shown on the Trinity Highway Product, LLC. drawings. The asphalt foundations must meet or exceed the size for the concrete foundations. Failure to follow this warning could result in serious injury or death in the event of a collision.
	WARNING: Ensure that all of the HEART Warnings, Cautions and Important statements within the HEART manual are completely followed. Failure to follow this warning could result in serious injury or death in the event of a collision.
	WARNING: Always use safety precautions when performing installation, mixing chemicals, and/or moving heavy equipment. Wear steel toe shoes, gloves, safety goggles and back protection. Failure to follow this warning could result in serious injury or death to the workers and/or bystanders.
	WARNING: Be aware of the hazards of using compressed air (small objects may become projectiles). Failure to follow this warning can result in serious injury or death to the workers and/or bystanders.
	CAUTION: Before installing the HEART, ensure that no parts are frayed, damaged, or broken. Failure to follow this warning could result in serious injury to the workers and/or bystanders.

GENERAL INFORMATION

HEART SPECIFICATIONS

The Hybrid Energy Absorbing Reusable Terminal (HEART) is a Test Level 3 Bi-directional Crash Cushion and is shipped completely assembled with the Base Unit, Front Base Plate and Post assembly, all the side panels and nose panel, and Backup structure. The total length of the HEART is 26'2" long. The weight of the HEART completely assembled is 2,700 lbs.



IMPORTANT: READ SAFETY INSTRUCTIONS THOROUGHLY AND FOLLOW THE SUGGESTED SAFE PRACTICES BEFORE INSTALLING/REPAIRING THE HEART. Failure to follow this warning can result in serious injury or death to the worker and/or bystanders. Please keep these instructions for later use.



WARNING: Ensure that all of the HEART Warnings, Cautions, and Important statements within the HEART manual are completely followed. Failure to follow this warning could result in serious injury or death in the event of a collision.

HEART

To facilitate the use of this Manual, the Plan and Elevation views show the components of the HEART and should be thoroughly reviewed before starting installation or repair. Refer to drawings for details (See Figure 1)

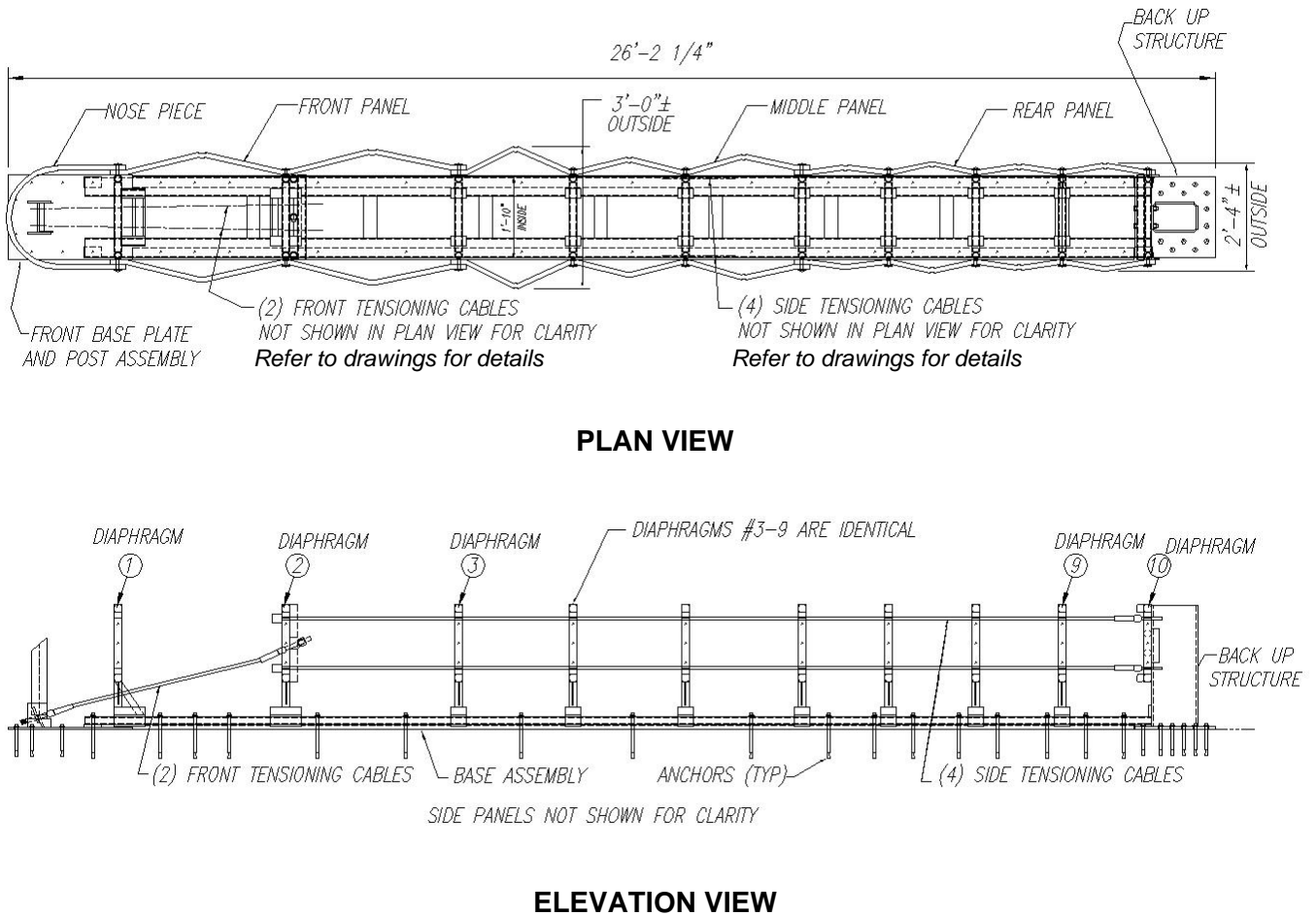

Figure 1 – Major Components of the HEART

Bill Of Material

The part number of a complete HEART unit is PN 26073.

Only **APPROVED** Trinity Highway Products replacement parts are allowed.



WARNING: Use only Trinity Highway Products' parts for installing/repairing the HEART. The installation/repair of unauthorized accessories is strictly prohibited. Failure to follow this warning could result in serious injury or death in the event of a vehicle impact with a NON-APPROVED system.

Part Number	QTY	Description	LBS/EA	Kg/EA
26060A	1	DIAPHRAGM #1	80	36
26061A	1	DIAPHRAGM #2	114	52
26062A	7	DIAPHRAGM #3-9	59	27
26063A	1	DIAPHRAGM #10	71	32
26064B	1	HDPE NOSE PIECE	54	24
26065B	2	HDPE FRONT PANEL	83	37
26066B	2	HDPE MIDDLE PANEL	83	37
26067B	2	HDPE REAR PANEL	83	37
26068A	1	COMPLETE BASE UNIT	749	340
26071G	20	PLT WSHR (5/16"x2"x1'- 2")	3	1
26072A	1	BACKUP POST	288	130
26074A	1	FRONT BASEPLATE/POST ASS'LY	159	72
3000G	2	3/4"Ø x 6'- 6" CABLE	14	6
3034G	4	3/4" x 6 x 19 x 19'- 7" CABLE	22	10

SHOP HARDWARE

Only **APPROVED** Trinity Highway Products replacement parts are allowed.



WARNING: Use only Trinity Highway Products' parts for installing/repairing the HEART. The installation/repair of unauthorized accessories is strictly prohibited. Failure to follow this warning could result in serious injury or death in the event of a vehicle impact with a NON-APPROVED system.

PART NUMBER	QTY	Description	MATL SPEC
4902G	8	1" ROUND WASHER	F436
3910G	14	1"HEX NUT	A563 GR A
3717G	2	¾"ø x 2 ½" HEX HD BOLT	A325
3701G	2	¾" ROUND WASHER	F436
3704G	4	¾" HEX NUT	A563 GR DH
3742G	60	7/8" HEX NUT	A563 GR DH
3816G	42	7/8"ø x 5" RD HD BOLT	A449
3817G	18	7/8"ø x 6" RD HD BOLT	A449
4428G	4	5/8"ø x 3 ½" HEX HD BOLT	GR 5
4448G	4	5/8"ø x 5 ½" HEX HD BOLT	GR 5
4372G	8	5/8" ROUND WASHER	F436
3361G	8	5/8" HEX NUT	A563 GR DH
3045B	2	HEART PATENT LABEL	
4708G	2	¾"ø x 4" HEX HD BOLT	A325
3010G	4	¾" CABLE CLAMP	FORGED
4003G	4	¾" CABLE FERRULE (L6)	
4004B	4	¾" CABLE WEDGE (#6)	

HEART INSTALLATION INSTRUCTIONS

As packaged, the HEART includes all materials needed for a complete installation. Anchor bolts are used to secure the Base, Front Base Plate, and Backup Structure to the surface. It takes thirty-four (34) bolts to secure the Base, six (6) for the Front Base Plate, and fifteen (15) for the Backup Structure.

Trinity Highway Product, LLC drawings for the HEART should be used with these instructions.

SUGGESTED TOOL LIST

The following list shows suggested tools for installation of the HEART:

1. Forklift or Boom Truck (4000 pound capacity)
2. Lifting Slings or Chains
3. Air hammer/drill 35/50# capacity and appropriate power source
4. Rock drill bit 11/16" x 10" and 30" extender
5. Socket and Ratchet Set or Flat Wrenches-3/8" to 1-1/4"
6. Traffic control equipment
7. Gloves, safety goggles, and back protection for lifting
8. Dispensing Gun and Mixing Tubes for Hilti HIT HY-150 Adhesive

Note: HILTI dispensing gun and mixing tubes for HIT HY-150 adhesive are available from Trinity Highway Products, LLC. or directly from Hilti, Inc., at 800-879-8000 in the United States or 800-835-6051 in Canada.

SAFETY INSTRUCTIONS

Always use appropriate safety precautions when operating power equipment and mixing chemicals, and when moving heavy equipment and the HEART into its final position. Gloves, safety goggles, and back protection should be used.

Safety measures incorporating traffic control devices must be used to provide safety for personnel while at the installation/repair site.

SITE PREPARATION

It is important that the grading leading up to and adjacent to the HEART be flat so that the vehicle will not be in an erratic motion before impact. To prevent this, the cross slope should be no more than 12:1 and the HEART should not be placed directly behind a raised curb.

The base/surface that the HEART is to be installed on must be adequate to provide the required anchorage. The HEART can be installed on an 8-inch thick un-reinforced concrete base. The size of the concrete base is 4 feet wide and 28 feet 2 inches long. The HEART can be installed on the following bases/surfaces:

- 6 inch Reinforced Concrete
- 8 inch Un-reinforced Concrete
- 8 inch Minimum Asphalt
- 8 inch Minimum combination of Concrete and Asphalt

Existing concrete foundations or new concrete foundations must meet or exceed the dimensions shown on the Trinity Highway Product, LLC drawings. The asphalt foundations must meet or exceed the size for the concrete foundations.



WARNING: Ensure that the grading leading up to the HEART and around the system is flat so that the vehicle will not be in an erratic motion before impact. To prevent this, the cross slope should be no more than 12:1 and the HEART system should not be placed directly behind a raised curb.









WARNING: Existing concrete foundations or new concrete foundations must be of the dimensions shown on the Trinity Highway Product, LLC drawings. The asphalt foundations must meet or exceed the size for the concrete foundations. Failure to follow this warning could result in serious injury or death in the event of a collision.

LIFTING AND ALIGNING INSTALLATION INSTRUCTIONS

The HEART will arrive completely assembled as one unit. The weight of a complete HEART is 2700 pounds. Lift The HEART from the transporting vehicle at Diaphragms 3 and 10 locations with a forklift or other appropriate piece of equipment by threading lifting chains or slings directly through the top of the Diaphragms. If a forklift is used, the forks should be centered under the base at Diaphragm 5.

The HEART should be placed in its final planned location and not moved once this location is established. It should be aligned within 1° of the downstream barrier. Before placing the unit in its planned location, attach all appropriate brackets to Diaphragm 10.

	WARNING: When lifting or moving the HEART maintain control of the unit by guiding the end with a guide rope. Failure to follow this warning could result in serious injury or death.
	WARNING: If the unit can be impacted from the reverse direction, an appropriate transition will be required. The unit should be aligned so the transition pieces do not create a snagging point where they are connected to the HEART. Failure to follow this warning could result in serious injury or death in the event of a collision.
	WARNING: Do NOT attempt to move the HEART without attaching it to a forklift or boom truck (with a 4,000 lbs capacity). The HEART system weighs up to 2,700 lbs when fully assembled. Failure to follow this warning could result in serious injury or death to the workers and/or bystanders.
	WARNING: Existing concrete foundations or new concrete foundations must meet or exceed the dimensions shown on the Trinity Highway Product, LLC drawings. The asphalt foundations must meet or exceed the size for the concrete foundations. Failure to follow this warning could result in serious injury or death in the event of a collision.
	WARNING: Use caution when working near public roads. Be mindful of vehicles in motion nearby. Failure to follow this warning could result in serious injury or death to the workers and/or bystanders.
	WARNING: Always use safety precautions when performing installation, mixing chemicals, and/or moving heavy equipment. Wear steel toe shoes, gloves, safety goggles, and back protection. Failure to follow this warning could result in serious injury or death to the workers and/or bystanders.
	WARNING: Ensure that the grading leading up to the HEART and around the system is flat so that the vehicle will not be in an erratic motion before impact. To prevent this, the cross slope should be no more than 12:1 and the HEART system should not be placed directly behind a raised curb.

Complete the following steps to lift and align the HEART for installation:





Step	Action
1.	Read safety instructions thoroughly before installing the HEART.
2.	Thread the lifting chains or slings of the forklift or boom truck through the top of the frames of the Base Unit. Note: When lifting a Base Unit with the Backup Structure, the lifting point should be at frames 3 and 10. If there is no Backup Structure attached to the Base Unit, then the lifting points should be at frames 3 and 8 or 4 and 7.
3.	Ensure that the Base Unit can be handled safely prior to moving.
4.	Lift the complete Base Unit from the transporting vehicle.
5.	Maintain control while lifting and moving the Base Unit by guiding the end with a guide rope.
6.	Before placing the unit in its planned location, attach all appropriate brackets to Diaphragm 10. See the <i>UNI-DIRECTION INSTALLATION section, Option 2: USE OF BRACKETS</i> for the appropriate brackets.

7.	Place the unit in its planned location. Do not move the system once this location is established.
8.	Align the unit to within 1° of the downstream barrier.

ANCHORING INSTALLATION INSTRUCTIONS



Once the HEART is placed in the final location, it is time to anchor it to the foundation. The anchoring stud length is dependent on the type of surface on which the HEART is placed.

Note: During shipping, the Diaphragms may shift, thus making some of the holes inaccessible without moving the frames back into position. Some HEART units will have a “shipping bolt” that must be removed prior to anchoring the unit. The nut of this bolt will be under the front base plate. If the nut is not present under the plate, skip Step 1.

	WARNING: Use caution when working near public roads. Be mindful of vehicles in motion nearby. Failure to follow this warning could result in serious injury or death to the workers and/or bystanders.
	WARNING: Always use safety precautions when performing installation, mixing chemicals, and/or moving heavy equipment. Wear steel toe shoes, gloves, safety goggles, and back protection. Failure to follow this warning could result in serious injury or death to the workers and/or bystanders.
	WARNING: Be aware of the hazards of using compressed air (small objects may become projectiles). Failure to follow this warning can result in serious injury or death to the workers and/or bystanders.
	WARNING: Use only Trinity Highway Products' parts for the installation of the HEART. The installation of unauthorized accessories is strictly prohibited. Failure to follow this warning could result in serious injury or death in the event of a vehicle impact with a NON-APPROVED system.
	WARNING: Do NOT modify the HEART in any way. Failure to follow this warning could result in serious injury or death in the event of a collision.

Complete the following steps to anchor the HEART:

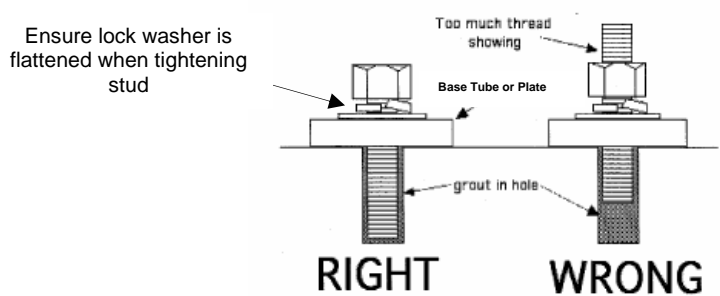
Step	Action															
1.	Remove the two (2) ¾ inch x 4 inch bolts holding the Front Base Plate to the HEART Base. The nuts are removed from under the plate by lifting the plate slightly.															
2.	Drill holes for the anchors into the foundation using the holes in the base plate(s) and the base rails as a template. Use a 3/4" drill bit to drill holes.															
3.	For the Base Rails , drill the holes to the depth indicated for the surface foundation on which the unit is placed. <table border="1" data-bbox="292 1480 1453 1659"> <thead> <tr> <th>Foundation</th> <th>Anchor Stud Size</th> <th>Hole Depth</th> </tr> </thead> <tbody> <tr> <td>6" Reinforced Concrete</td> <td>5/8" d x 10" long</td> <td>6"</td> </tr> <tr> <td>8" Un-reinforced Concrete</td> <td>5/8" d x 10" long</td> <td>6"</td> </tr> <tr> <td>8" Minimum Asphalt</td> <td>5/8" d x 18" long*</td> <td>14"</td> </tr> <tr> <td>8" Minimum combination of Concrete and Asphalt</td> <td>5/8" d x 18" long</td> <td>14"</td> </tr> </tbody> </table> <p>* If asphalt is located over a minimum of 6-inches of concrete, the 18-inches anchor studs can be cut off to a total length equal to the asphalt thickness plus 10 inches.</p>	Foundation	Anchor Stud Size	Hole Depth	6" Reinforced Concrete	5/8" d x 10" long	6"	8" Un-reinforced Concrete	5/8" d x 10" long	6"	8" Minimum Asphalt	5/8" d x 18" long*	14"	8" Minimum combination of Concrete and Asphalt	5/8" d x 18" long	14"
Foundation	Anchor Stud Size	Hole Depth														
6" Reinforced Concrete	5/8" d x 10" long	6"														
8" Un-reinforced Concrete	5/8" d x 10" long	6"														
8" Minimum Asphalt	5/8" d x 18" long*	14"														
8" Minimum combination of Concrete and Asphalt	5/8" d x 18" long	14"														
4.	For the Front and Rear Base Plates , drill the holes to the depth indicated for the surface foundation on which the unit is placed. <table border="1" data-bbox="292 1806 1453 1984"> <thead> <tr> <th>Foundation</th> <th>Anchor Stud Size</th> <th>Hole Depth</th> </tr> </thead> <tbody> <tr> <td>6" Reinforced Concrete</td> <td>5/8" d x 7.5" long</td> <td>6"</td> </tr> <tr> <td>8" Un-reinforced Concrete</td> <td>5/8" d x 7.5" long</td> <td>6"</td> </tr> <tr> <td>8" Minimum Asphalt</td> <td>5/8" d x 18" long*</td> <td>16.5"</td> </tr> <tr> <td>8" Minimum combination of Concrete and Asphalt</td> <td>5/8" d x 18" long</td> <td>16.5"</td> </tr> </tbody> </table>	Foundation	Anchor Stud Size	Hole Depth	6" Reinforced Concrete	5/8" d x 7.5" long	6"	8" Un-reinforced Concrete	5/8" d x 7.5" long	6"	8" Minimum Asphalt	5/8" d x 18" long*	16.5"	8" Minimum combination of Concrete and Asphalt	5/8" d x 18" long	16.5"
Foundation	Anchor Stud Size	Hole Depth														
6" Reinforced Concrete	5/8" d x 7.5" long	6"														
8" Un-reinforced Concrete	5/8" d x 7.5" long	6"														
8" Minimum Asphalt	5/8" d x 18" long*	16.5"														
8" Minimum combination of Concrete and Asphalt	5/8" d x 18" long	16.5"														

	* If asphalt is located over a minimum of 6-inches of concrete, the 18-inches anchor studs can be cut off to a total length equal to the asphalt thickness plus 7 ½ inches.
5.	Per anchor manufacturer's instruction, blow clean each drilled hole.
6.	To ensure proper mixing of the two-part adhesive, discard the first 2 to 3 trigger pulls of the new tube. Insert the Hilti HY-150 adhesive into the dispensing gun and mixing tubes then dispense the adhesive into each drilled hole. Fill the hole with enough adhesive to cause a small amount to be pushed out when the stud is installed.
7.	Place a nut, washer, and lock washer on the stud. Place the nut so it is flush with the end of the stud. Place the washer and lock washer between the nut and the base tube or plate. (See Figure 2 for the right and wrong way to install the stud and washers.) Ensure the lock washer is flattened when tightening the stud.
	<p>Ensure lock washer is flattened when tightening stud</p>  <p style="text-align: center;">RIGHT WRONG</p>
8.	Install the stud into the hole.
9.	Tighten the installed anchor nuts after the adhesive has set (see adhesive manufacturer's instructions for gel and final set times under various environmental conditions). Ensure lock washer is flattened when tightening stud.
10.	After the HEART has been anchored to the surface, check the Side Tensioning Cables to ensure they are taut. If they are not taut, tighten the 1-inch nut at Diaphragm 10. After the cable has been made taut, tighten the second 1-inch nut up to the first nut.
11.	Check the two cables between the Front Base Plate/Post Assembly and Diaphragm 2 to ensure they were not loosened during shipping. If they are not taut, tighten the nut(s) at Diaphragm 2. (See Figure 3)
	 <p style="text-align: center;">Figure 3 - Diaphragm 2</p>

INSTALLATION OF THE HEART WITH BACKUP STRUCTURE

If the installation of the HEART includes a Backup Structure, the structure will already be attached to the HEART. The only installation required is to bolt the Backup Structure to the surface. This will be done using the procedures in the *ANCHORING INSTALLATION INSTRUCTION* section.

UNI-DIRECTIONAL INSTALLATION

Reference Trinity Highway Products' Drawing SS 1507.

UNI-DIRECTIONAL/RIGID OBJECT INSTALLATION

When the HEART is used for shielding a rigid object, the type of object will dictate the type installation required. The different means of installation are: Use of a Backup Structure; Use of Brackets; or Bolting Directly to the End of the Object.

Complete Option 1, Option 2, or Option 3 for attaching the HEART to a Rigid Barrier:

Option 1: USE OF BACKUP STRUCTURE

When the HEART cannot be attached to the rigid object, the backup structure will be required. The backup structure comes attached to the HEART. It will need to be bolted to the surface with fifteen (15) 5/8" anchor studs. See the *ANCHORING INSTALLATION INSTRUCTION* section for stud sizes and instructions for installation.

Option 2: USE OF BRACKETS

The HEART can be attached to a safety shape barrier, single slope barrier, a narrow vertical faced wall (7" min. to 12" max.), or a wide vertical faced wall (12 3/4" min. to 18" max.) with the use of brackets and for some situations, by bolting into the barrier/wall. See Figures 4a through 4f for bracket use and bolting to the barrier locations.

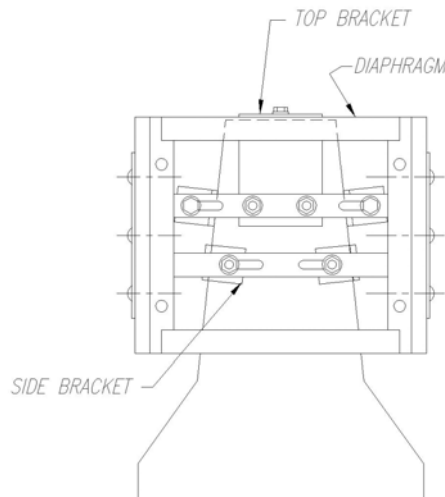

2'-0" WIDE SAFETY SHAPE

4 ~ SIDE BRACKETS & 1 ~ TOP BRACKET

10 ~ 5/8" ANCHORS INTO CONCRETE

2 ANCHORS PER BRACKET

Figure 4a - Bolting Diaphragm 10 to Safety Shape Barrier

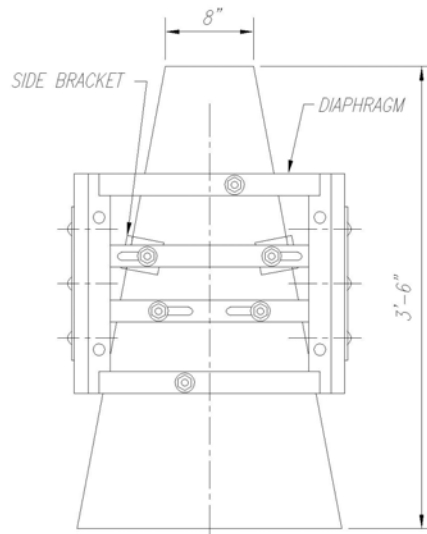

2'-0" WIDE SINGLE SLOPE
 2 ~ SIDE BRACKETS
 8 ~ 5/8" ANCHORS INTO CONCRETE
 2 ANCHORS PER BRACKET
 4 ANCHORS DIRECT THRU DIAPHRAGM

Figure 4b - Bolting Diaphragm 10 to Single Slope Barrier

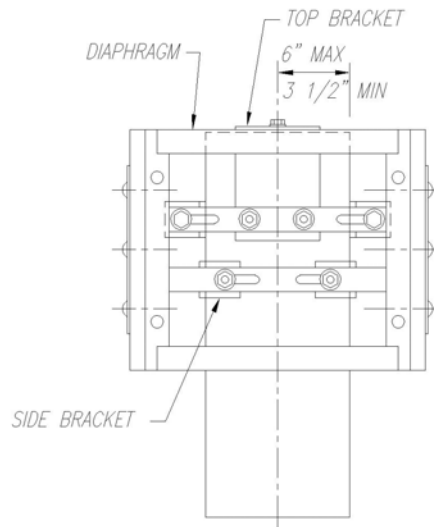

7" MIN / 12" MAX WALL
 4 ~ SIDE BRACKETS & 1 ~ TOP BRACKET
 10 ~ 5/8" ANCHORS INTO CONCRETE
 2 ANCHORS PER BRACKET

Figure 4c - Bolting Diaphragm 10 to Narrow Vertical Faced Wall (7" min to 12" max)

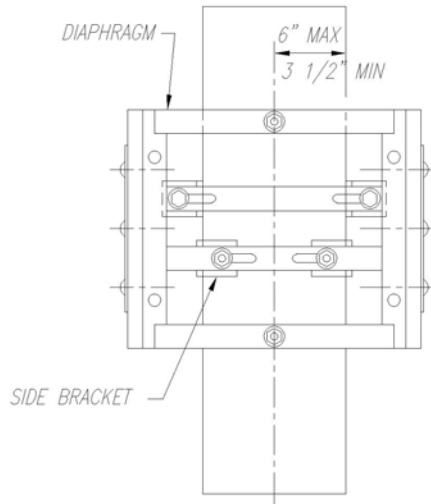

7" MIN / 12" MAX WALL (HT > 32 5/8")

- 4 ~ SIDE BRACKETS
- 10 ~ 5/8" ANCHORS INTO CONCRETE
- 2 ANCHORS PER BRACKET
- 2 ANCHORS DIRECT THRU DIAPHRAGM

Figure 4d - Bolting Diaphragm 10 to Narrow Vertical Faced Tall Wall (7" min to 12" max)

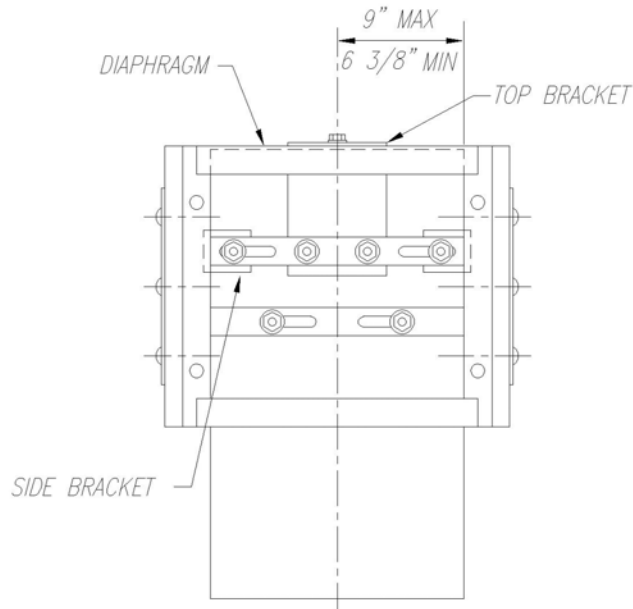

12 3/4" MIN / 18" MAX WALL

- 2 ~ SIDE BRACKETS & 1 ~ TOP BRACKET
- 8 ~ 5/8" ANCHORS INTO CONCRETE
- 2 ANCHORS PER BRACKET
- 2 ANCHORS DIRECT THRU DIAPHRAGM

Figure 4e - Bolting Diaphragm 10 to Wide Vertical Faced Wall (12 3/4" min to 18" max)

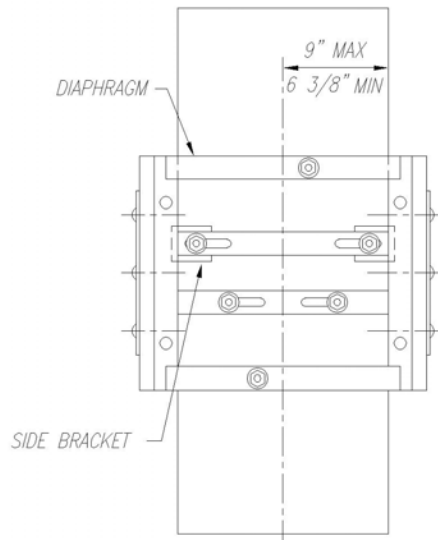

12 3/4" MIN / 18" MAX WALL (HT > 32 5/8")
 2 ~ SIDE BRACKETS
 8 ~ 5/8" ANCHORS INTO CONCRETE
 2 ANCHORS PER BRACKET
 4 ANCHORS DIRECT THRU DIAPHRAGM

Figure 4f - Bolting Diaphragm 10 to Wide Vertical Faced Tall Wall (12 3/4" min to 18" max 7)

Complete the following steps to attach the HEART to the barrier. Reference Trinity Highway Products' Drawing SS 1507.

Step	Action
1.	Bolt the brackets to the Diaphragm with a total of six (6) 5/8" x 4" H.S. bolts; one (1) each for the transition side brackets and two (2) for the top bracket. A 5/8" flat washer is placed on the bolt.
2.	Insert the bolt through the holes in the bracket and the slotted holes in the Diaphragm. The bolt heads should be on the barrier side of the Diaphragm.
3.	Place a 5/8" flat washer, 5/8" lock washer, and 5/8" nut on the bolt. The nuts should not be tightened until after the brackets are secured to the barrier.
4.	Using the brackets as a template, drill holes per expansion anchor manufacturer's suggestions in the barrier for the 3/4" diameter expansion anchors, 5 1/2" LG anchors for the top bracket, and 4 1/4" LG anchors for side brackets.
5.	With the anchors installed, attach the brackets to the barrier by placing a washer and nut on the anchor, and the nut tightened.
6.	Tighten the nuts and the nuts securing the brackets to the Diaphragm.

UNI-DIRECTIONAL/ PRE-CAST CONCRETE BARRIER INSTALLATION

When the HEART is attached to a pre-cast concrete barrier, brackets are used to secure Diaphragm 10 to the barrier. Five (5) brackets, [four (4) transitions side brackets, and one (1) top bracket] are used to make this connection. See the *UNI-DIRECTIONAL/RIGID OBJECT INSTALLATION* section, Option 2 for the installation of the brackets. For this installation, the concrete barrier must be anchored. See the *RESTRAINING PRE-CAST BARRIER* section for anchoring instructions. Reference Trinity Highway Products' Drawing SS 1507.

RESTRAINING PRE-CAST BARRIER

When attaching the HEART to a pre-cast barrier, complete the following steps for anchoring the barrier. Reference Trinity Highway Products' Drawing SS 1507.

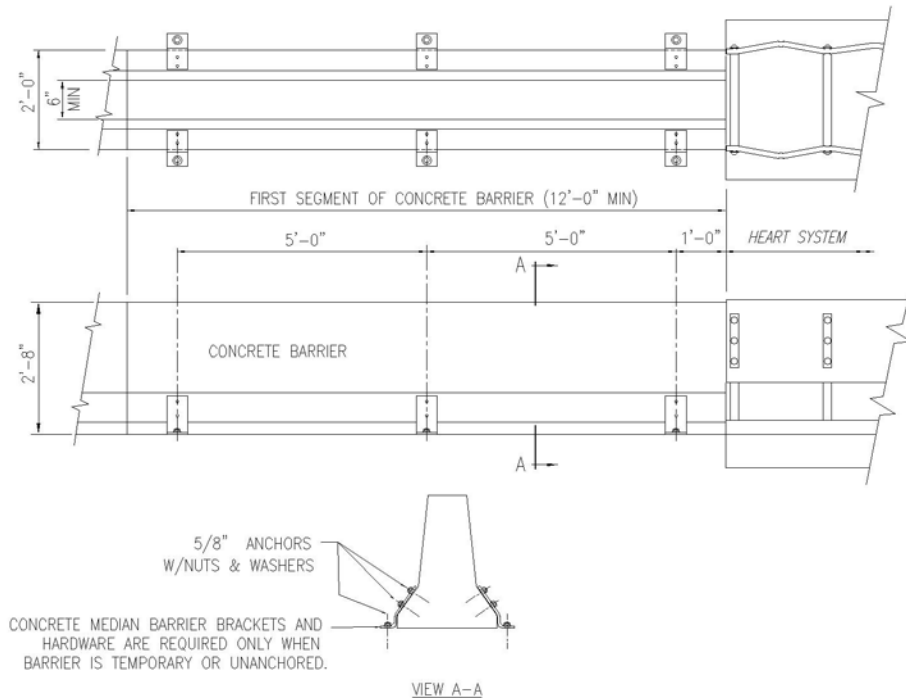
Step	Action
<p>1.</p>	<p>Anchor the barrier with six (6) Barrier Anchor Brackets. (See Figure 5)</p>  <p style="text-align: center;">Figure 5- Pre-Cast Barrier</p>
<p>2.</p>	<p>Secure the Barrier Anchor Brackets to the barrier with 5/8" x 7 1/2" anchor studs with adhesive. Secure the Barrier Anchor Brackets to the concrete roadway surface with 5/8" x 7 1/2" anchor studs with adhesive. Secure the Barrier Anchor Brackets to an asphalt roadway surface with 5/8" x 18" anchor studs with adhesive.</p>
<p>3.</p>	<p>Using the Barrier Anchor Brackets as a template, drill holes into the barrier per anchor manufacturer's suggestions. Two (2) anchors are required for each barrier.</p>
<p>4.</p>	<p>Secure the Barrier Anchor Brackets to the barrier by placing a washer and nut on each of the anchors. Tighten the nuts after the adhesive has set.</p>
<p>5.</p>	<p>Using the Barrier Anchor Brackets as a template, drill holes per anchor manufacturer's suggestions into the roadway surface. Follow the procedures in the ANCHORING INSTALLATION INSTRUCTIONS section, Steps 4-9. Only one (1) anchor per bracket is required.</p>

BI-DIRECTIONAL INSTALLATION



WARNING: If the unit can be impacted from the reverse direction, an appropriate transition will be required. The unit should be aligned so the transition pieces do not create a snagging point where they are connected to the HEART. Verify that the panels are lapped in accordance with Trinity Highway Products' Drawing SS 1508. Failure to follow this warning could result in serious injury or death in the event of a collision.

BI-DIRECTIONAL/PERMANENT BARRIER INSTALLATION

For a Bi-Directional Installation, a Thrie Beam Transition Panel (PN305G) is required for the reverse direction of traffic. Reference Trinity Highway Products' Drawing SS 1506.

The HEART should be attached to the barrier the same as described in the *UNI-DIRECTIONAL/PRE-CAST CONCRETE BARRIER INSTALLATION* section.

Step	Action
1.	Remove the 7/8" x 5" R.H bolts and plate washer holding the side panels to Diaphragm 10 (the bolts and plate washers will be reused in Step 3).
2.	Attach the bent transition plate to the HEART by placing the transition plate on the outside of the side panel.
3.	Reinstall the bolts and plate washers from Step 1. Next, tighten all nuts.
4.	Attach the end terminals, PN975G, to each end of the Thrie Beam Transition Panel (PN305G) using twelve (12) 5/8" x 1 1/4"HGR splice bolts and nuts at each location. The end terminal attached to the Thrie Beam Panel for the barrier end should be on the outside of the Thrie Beam Panel. The end terminal attached to the Thrie Beam Panel for the HEART end should be behind the Thrie Beam Panel.
5.	Attach the shaped wood block to the transition panel at the locations shown in Figure 6. Field drill pilot holes in the shaped block with a 1/4" drill bit. Inserting two (2) 5/8" x 3" lag screws and a washer under the head of the screw.
Figure 6- Shaped Wood Block	
6.	Attach the HEART end of the transition panel to the bent transition plate with seven (7) 3/4" x 2" hex head bolts, flat washers, and a hex nut by placing a flat washer on the hex head bolt and insert the hex head bolt through a hole in the end terminal and transition plate.
7.	Place a flat washer and nut on the bolts.
8.	Tighten the nuts after all of the bolts at both ends have been installed.

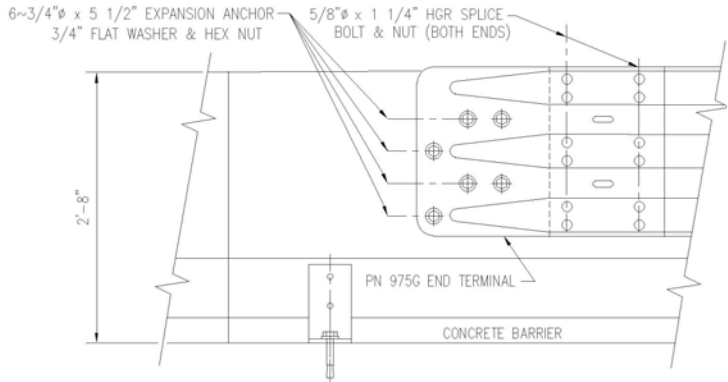
<p>9.</p>	<p>Attach the barrier end of the transition panel to the barrier with six (6) 3/4" x 5 1/2" expansion anchors. Using the transition panel as a template, drill holes per the expansion anchor manufacturer's suggestions into the barrier for the expansion anchors.</p>  <p style="text-align: center;">Figure 7 – Transition Panel</p>
<p>10.</p>	<p>With the anchors installed, secure the barrier end of the transition panel with a washer and nut on each anchor. Once all the nuts are installed on both ends, they should be tightened.</p>

BI-DIRECTIONAL/PRE-CAST CONCRETE BARRIER INSTALLATION

For a Bi-Directional Installation, a Thrie Beam Transition Panel (PN305G) is required for the reverse direction of traffic. Reference Trinity Highway Products' Drawing SS 1506.

The HEART should be attached to the barrier the same as described in the *UNI-DIRECTIONAL/PRE-CAST BARRIER INSTALLATION* section. The barrier should be anchored per the *RESTRAINING UN-ANCHORED BARRIER* section.

The Thrie Beam Transition Panel should be installed per the *BI-DIRECTIONAL/PERMANENT BARRIER INSTALLATION* section.

DELINEATION

The delineation of the Nose Panel can be customized for the traffic flow for which the HEART is installed. Four pieces of reflective tape are provided with the HEART and can be used to delineate left shoulder, right shoulder, and gore applications.

	<p>WARNING: Ensure that the HEART and delineation used meet all federal, state/specifying agency, and local specifications. Failure to follow this warning could result in serious injury or death in the event of a collision.</p>
---	--

DELINEATION

Complete the steps below to apply the delineation:

Step	Action
1.	Install proper delineation for the HEART in accordance with the state/specifying agency's MUTCD (all four identical pieces of reflective tape can be used to create the three designs as shown in Figure 8).

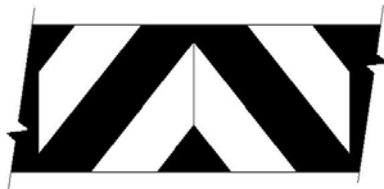

Gore Pattern



Right Shoulder Pattern



Left Shoulder Pattern

Figure 8 - Nose Delineation

HEART REPAIR INSTRUCTIONS

The Hybrid Energy Absorbing Reusable Terminal (HEART) is a Test Level 3 Bi-directional Crash Cushion.

The HEART repair will depend on the severity of the impact. It will range from no repair to replacing 5/16 inch bolt to replacing Diaphragm or side panel. Minor side impacts could require no repair. End on impacts will require pulling the system back into place and replacing the Nose post bolt. On severe side impacts, there may be the need to replace a Diaphragm and/or side panel and in some cases, an anchor bolt or two.

Trinity Highway Products' drawings for the HEART should be used with these instructions.

SUGGESTED TOOL LIST

The following list shows suggested tools for installation of the HEART:

1. Forklift or Boom Truck (4000 pound capacity)
2. Lifting Slings or Chains
3. Air hammer/drill 35/50# capacity and appropriate power source
4. Rock drill bit 11/16" x 10" and 30" extender
5. Socket and Ratchet Set or Flat Wrenches-3/8" to 1-1/4"
6. Traffic control equipment
7. Gloves, safety goggles, and back protection for lifting
8. Dispensing Gun and Mixing Tubes for Hilti HIT HY-150 Adhesive

Note: HILTI dispensing gun and mixing tubes for HIT HY-150 adhesive are available from Trinity Highway Products, LLC or directly from Hilti, Inc., at 800-879-8000 in the United States or 800-835-6051 in Canada.

SAFETY INSTRUCTIONS

Always use appropriate safety precautions when operating power equipment and mixing chemicals, and when moving heavy equipment and the HEART into its final position. Gloves, safety goggles, and back protection should be used.

Safety measures incorporating traffic control devices must be used to provide safety for personnel while at the installation/repair site. Trinity Highway Products, LLC offers an economical and effective truck mounted attenuator, the MPS-350, for the protection of workers in work zones. For more information on the MPS-350 call 800-644-7976, or visit the Trinity Highway Products' website at www.highwayguardrail.com.

MAJOR COMPONENTS OF THE HEART

To facilitate the use of these instructions, Figure 9 shows the HEART with major parts labeled.

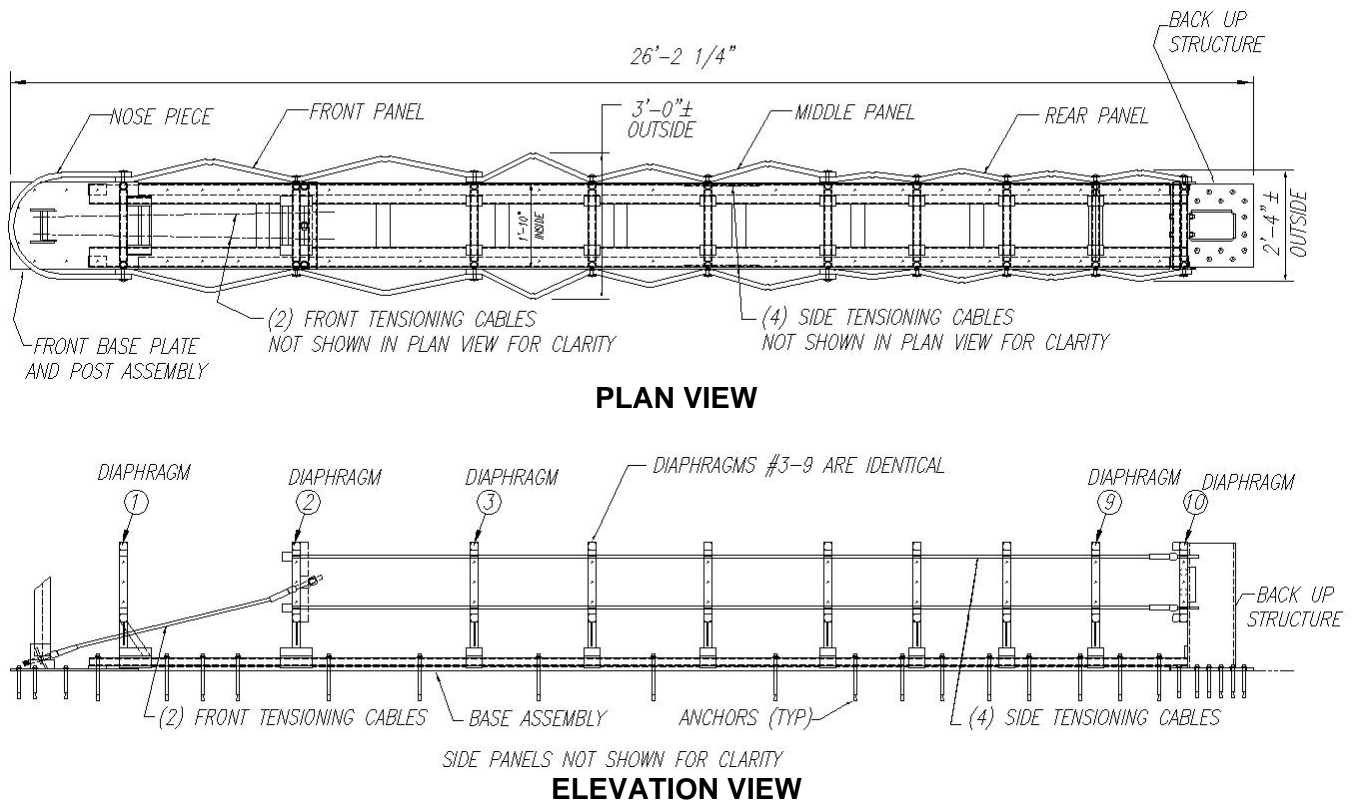

Figure 9 - Major Components of the HEART

REPAIRING HEAD/ANGLE IMPACT ON THE NOSE

When the HEART is impacted head on or on the nose, the CRP will release and the system will compress. The repair will be the same no matter how much it compresses.

Complete the following steps:

Step	Action
1.	Pull the system in place by pulling on Diaphragm 1. If the Diaphragms bind while pulling on Diaphragm 1, other Diaphragms may need to be pulled as well.
2.	Stop pulling when the bolt centerline of Diaphragm 1 is approximately 2 inches from the end of the base.
3.	After pulling, Diaphragm 1 should remain about 5 inches from the end of the base.
4.	Once the unit is aligned, the CRP post should be reinstalled.
5.	This is done by securing the top post to the bottom stub with a 5/16 inch bolt, nut, and washer.
6.	Once the CRP post is installed, reinstalled the front tensioning cables.
7.	Remove the two nuts and washer from each cable.
8.	Install the cable ends through the holes in the CRP post and install the washer and nuts.
9.	Place the washer and first nut on the thread stud.
10.	Tighten the nut up until the cable is taut.
11.	Once the cable is taut, tighten the second nut up to the back of the first nut (see Figure 10).



Figure 10 – CRP Installation

12.	If the reflective delineation has been damaged, it needs to be replaced. This should be done in accordance with the instructions in the Damaged Nose Section.
------------	---

REPAIRING DAMAGED NOSE SECTION

The nose section should be checked to make sure it is not damaged. If the nose is damaged, it must be replaced. Complete the following steps:

Step	Action
1.	Remove the damaged nose section by removing the 3 nuts from the 7/8" R.H. bolts and the side washer from each side of the nose section.
2.	Align the nose section to the first panel depending on a UNI-DIRECTIONAL or BI-DIRECTIONAL installation. For a UNI-DIRECTIONAL installation, the nose section ends are placed to the outside of the first side panel. For a BI-DIRECTIONAL installation, the nose section end on the approach traffic side is placed on the outside of the first side panel. The nose section end for the opposing traffic side is placed under the first side panel.
	
Figure 11 – NOSE SECTION	
3.	Place a 7/8" R.H. bolt through each of the three holes in the side washer.
4.	With the three R.H. bolts placed in the side washer, place the bolts through the holes in the nose section, side panel, and Diaphragm for each side of the nose section.
5.	Place a nut on each bolt and tighten the nuts.

Once the nose section has been installed, the delineation should be installed. The delineation of the Nose Panel should be the same as what was on the nose section removed. Four pieces of reflective tape are required to delineate the left shoulder, right shoulder, and gore applications. All four identical pieces of reflective tape can be used to create the three designs as shown in Figure 12.

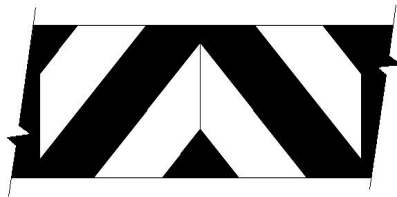

Gore Pattern

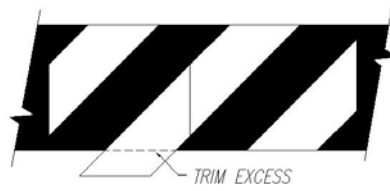

Right Shoulder Pattern

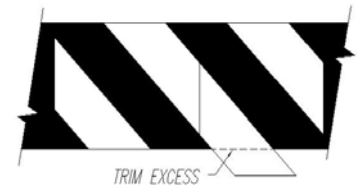

Left Shoulder Pattern

Figure 12 – Nose Delineation Options

REPAIRING SIDE IMPACT

Minor side impacts should create no damage to the HEART. A more severe impact could cause damage to a Diaphragm or side panel. If the Diaphragm is damaged, it will need to be replaced.

REPLACING A DIAPHRAGM 1 OR 2

To remove or replace a damaged Diaphragm 1, complete the following steps:

Step	Action
1.	Unbolt the nose section and the side panels from the Diaphragm. Remove the three (3) bolts and plate washer from each side of the Diaphragm. This will release the Diaphragm from the side panel and nose section.
2.	Remove the Diaphragm from the HEART by sliding it off the base assembly rails.
3.	Install a new Diaphragm 1 on base assembly rails. It should be placed approximately 2 inches from the end of the base.
4.	Attach the side panels and nose section by replacing the washers and bolts and nuts previously removed.
5.	Install the CRP post and front tensioning cables using the instructions in the <i>REPAIRING THE HEAD/ANGLE IMPACT ON THE NOSE</i> section.

To remove or replace a damaged Diaphragm 2, complete the following steps:

Step	Action
1.	Unbolt the side panels from the Diaphragm. Remove the three (3) bolts and plate washer from each side of the Diaphragm. This will release the Diaphragm from the side panel
2.	The side cables and front tension cables need to be removed from the Diaphragm. To remove the side cables from the ferrule, loosen the nuts on the cables at Diaphragm 10.
3.	With the side cables slack, remove the ferrule from the cable.
4.	Remove the front tension cables from the Diaphragm by removing the nut and washer from each cable.
5.	With the cables removed from the Diaphragm, the Diaphragm is removed from the HEART by sliding it off the base assembly rails. If Diaphragm 1 is not being replaced, it will be necessary to remove it from the HEART for removal Diaphragm 2. Remove Diaphragm 1 following the instructions for the replacement of Diaphragm 1.
6.	Install a new Diaphragm 2 on base assembly rails.
7.	Attach the side panels and nose section, lapping them in the direction of traffic by replacing the washers, bolts, and nuts previously removed from Diaphragms 1 and 2. (See Drawing SS 1508)
8.	Pull the unit out until Diaphragm 1 is approximately 2 inches from the end of the base.
9.	The side cables need to be secured to the Diaphragm 2. Push each cable through the holes in the Diaphragm. If the side cables were not loosened by loosening the nuts at Diaphragm 10, this should be done at this time.

10. Place a ferrule over the cable. (See Figure 13).

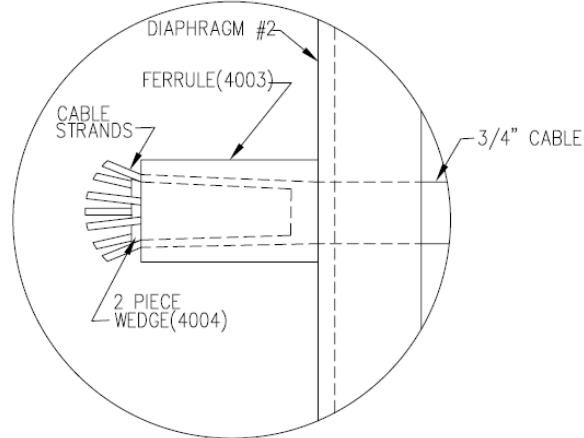

Figure 13 – CABLE FERRULE

11. There are six (6) cable strands and a center core strand. With the ferrule placed over the cable, the cable strands are separated and the two wedge pieces will be placed around the center core strand. There are three grooves in each of the wedge pieces. The remaining six (6) strands should be installed in the grooves, one strand in each groove (see Figure 14). The wedges should seat into the ferrule.



Figure 14 – CABLE INSTALLED IN FERRULE

12.	With the side cables secured to Diaphragm 2 with the ferrule, they need to be made taut. This is done by tightening the 1-inch nut at Diaphragm 10. After the cable has been made taut, the second 1-inch nut is tighten up to the first nut.
13.	To re-install the CRP post and the front tensioning cables to the post, see the <i>REPAIRING HEAD/ANGLE IMPACT ON THE NOSE</i> section.
14.	<p>The front tensioning cables are attached to Diaphragm 2. The two (2) cable ends are put in the holes in the Diaphragm (see Figure 15).</p> <div data-bbox="548 394 1179 890" data-label="Image"> </div> <p style="text-align: center;">Figure 15 – DIAPHRAGM/FRONT TENSIONING CABLES</p>
15.	Secure the cables to the Diaphragm with a round washer and a nut (see Figure 15).
16.	Check to make sure all of the cables are taut.

REPLACING A DIAPHRAGM (3 THROUGH 9)

To remove or replace a damaged Diaphragm, complete the following steps:

Step	Action
1.	Unbolt the side panels from the Diaphragm. See the SIDE PANEL REPAIR section for removing the side panel(s).
2.	Remove the three (3) bolts and plate washer from each side of the Diaphragm. This will release the Diaphragm from the side panel.
3.	Remove the Diaphragm from the HEART by cutting it out.
4.	The four (4) cables will also have to be removed from the Diaphragm by cutting them from the Diaphragm. Once the damaged Diaphragm is removed, a replacement can be installed.
5.	<p>Place a HEART Repair Diaphragm Lower Bracket (see Figure 16) on the base assembly rails.</p> <div data-bbox="592 619 1136 1333" data-label="Diagram"> </div>
6.	The HEART Repair Diaphragm (see Figure 16) is then inserted into the two HEART Repair Diaphragm Lower Brackets.

Figure 16 - HEART Repair Diaphragm Lower Bracket

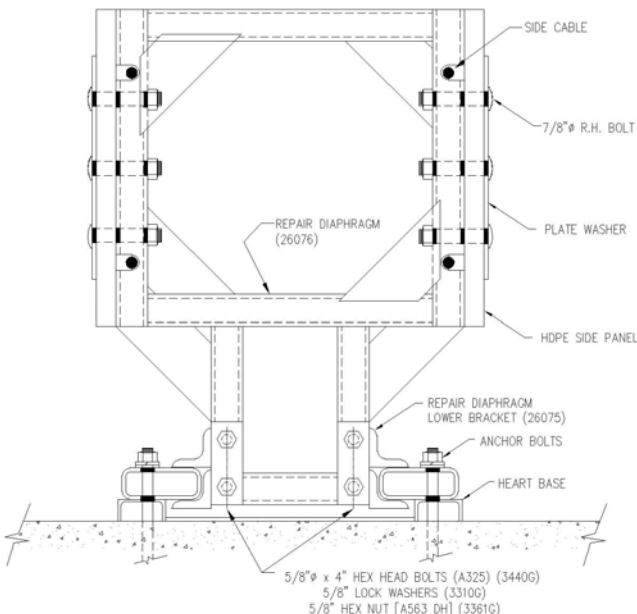
<p>7.</p>	<p>Secure the HEART Repair Diaphragm Bracket with a bolt unit made up of one (1) 5/8 inch x 4 inch bolt, one (1) lock washer, and nut (see Figure 17).</p>  <p style="text-align: center;">Figure 17 - HEART Repair Diaphragm for Diaphragm 3-9</p>
<p>8.</p>	<p>With the damaged Diaphragm replaced, the four (4) cables should be placed in the side slots of the Diaphragm (see Figure 16 and 17).</p>
<p>9.</p>	<p>Attach the side panels, lapping them in the direction of the traffic by replacing the washer, bolts, and nuts previously removed. (See Drawing SS 1508)</p>
<p>10.</p>	<p>Check the side cable to make sure they are taut. If tightening is required, this is done by tightening the nut on the end of the cable at Diaphragm 10.</p>
<p>11.</p>	<p>Once the cable has been made taut, the second nut should be tightened up to the first nut.</p>
<p>12.</p>	<p>Once all the cables are checked and no other repairs are required, the HEART is again operational.</p>

REPLACING TRANSITION PANEL

If any portion of the transition panel is damaged during an impact, that portion will have to be replaced.

Complete the following steps:



Step	Action
1.	Remove the Thrie Beam Transition Panel by removing the bolts that secure the end terminals at each end.
2.	Replace the damaged component.
3.	Re-install the Thrie Beam Transition Panel. See the <i>BI-DIRECTIONAL /PERMANENT BARRIER INSTALLATION</i> section for steps to complete the re-installation.

SIDE PANEL REPAIR

If during an end on or side impact and the side panel develops a crack, tear, or permanent deformities the side panel must be replaced.

There are three (3) different side panels on the HEART. Starting from the nose, they are Front Panel, Middle Panel, and Rear Panel.

Complete the following steps:

Step	Action
1.	<p>Remove the nuts on the inside of the Diaphragm. This will allow you to disconnect the damaged side panel from the Diaphragm (see Figure 18).</p>  <p style="text-align: center;">Figure 18 - Nuts and Bolts on the Inside of the Diaphragm</p>
2.	<p>Remove the plate washers and bolts from the Diaphragms (see Figure 19).</p>  <p style="text-align: center;">Figure 19 - Side Panel Plate Washer and Bolts</p>

3.	Remove the damaged side panel.
4.	Install the appropriate new side panels, lapping them in the direction of the traffic by replacing the washer, bolts, and nuts previously removed. (See Drawing SS 1508)
5.	Secure the side panel to the Diaphragm by placing the three bolts through the plate washers, through the side panel, and then through the holes in the Diaphragms.
6.	Place a washer and nut on each of the bolts. The nuts should be tightened to secure the side panel to the Diaphragms.
7.	Once the damaged side panel is replaced, and no other repairs are required, the HEART is again operational.

REPLACING ANCHOR BOLTS/RODS

If during an impact an anchor bolt/rod is pulled loose from the base, it will need to be reinstalled.

Complete the following steps:

Step	Action
1.	Remove the loosened bolt/rod from the hole.
2.	The hole should be cleaned out with a 3/4 inch drill. With the hole cleaned out, the adhesive can then be dispensed into the hole.
3.	The hole should be filled to a depth so when the stud is installed with a twisting motion, a small amount of the adhesive will come out.
4.	Place a nut, washer, and lock washer on the stud. Place the nut onto the end of the stud to a depth that will leave only a few threads showing when the nut is tightened. Place the washer and lock washer between the nut and the base tube or plate (see Figure 20 for the right and wrong way to install the stud and washers). Ensure the lock washer is flattened when tightening the stud.
<p style="text-align: center;">RIGHT WRONG</p> <p style="text-align: center;">Figure 20 - Proper Stud Installation</p>	
5.	Tighten the installed anchor nuts after the adhesive has set (see adhesive manufacturer's instructions for gel and final set times under various environmental conditions). Ensure lock washer is flattened when tightening stud.
6.	Once the dislodged anchor bolt/rod is replaced and no other repairs are required, the HEART is again operational.

APPENDIX DRAWINGS

Plan, Elevation, & Section Shop Assembly Details PN 26073 Unidirectional – E1 of E2.....	1501/PN26073
Plan, Elevation, & Section Shop Assembly Details PN 26073 – E2 of E2.....	1501/PN26073
Plan, Elevation, & Sections Unidirectional; Field Placement.....	SS 1502
Type F Concrete Median Barrier Plan, Elevation & Sections.....	SS 1506
Concrete Median Barrier Plan, Elevation, & Sections Unidirectional Traffic Only.....	SS 1507
Unidirectional & Bidirectional Traffic Flows HDPE Side Panel Lapping Schematic.....	SS 1508

Note: The drawings and the information shown thereon are copyrighted by Trinity Highway Products (2008) and the sole property of Trinity Highway Products'. Neither the drawings nor such information is to be used for any purpose other than that for which it was specifically furnished from Trinity Highway Products, LLC, nor is any reproduction authorized without written permission.

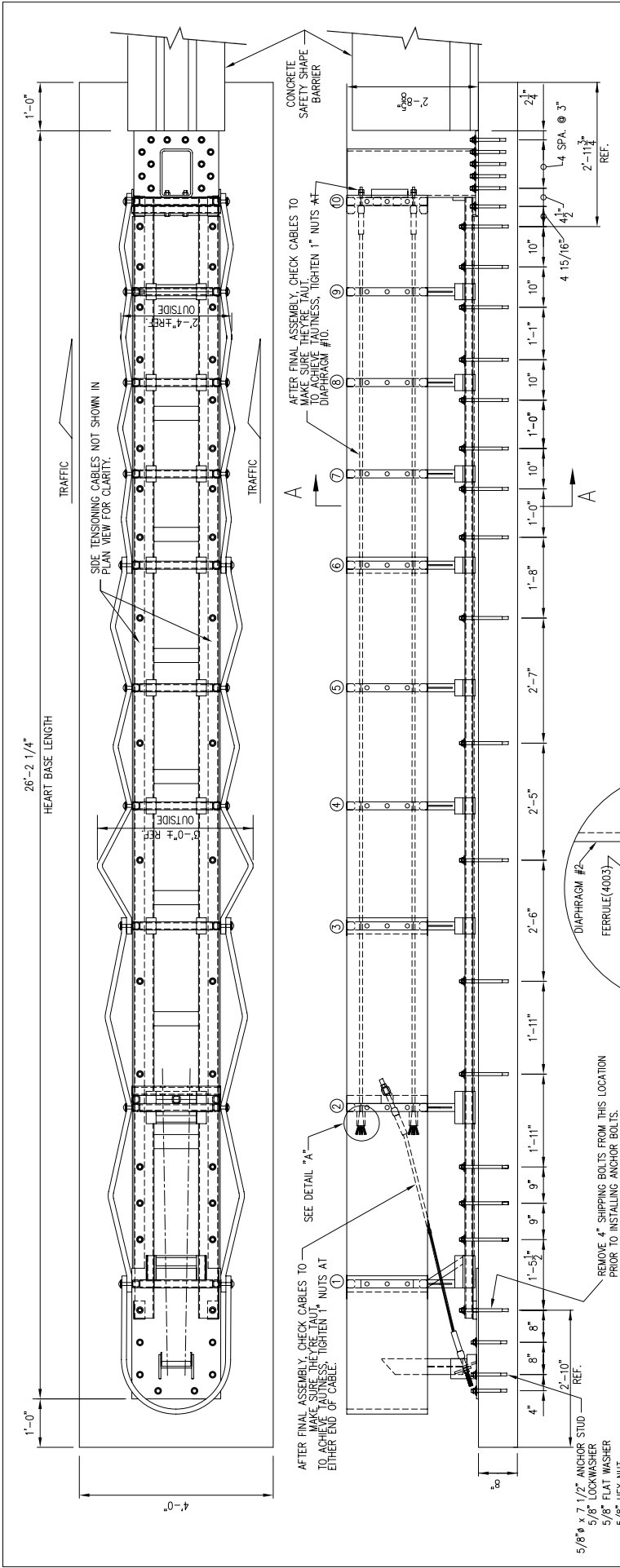

HEART BILL OF MATERIAL

PART NUMBER	QTY	DESCRIPTION
26073A	1	HEART UNIT (FULLY ASSEMBLED)
6668B	4	DELINEATOR DECAL OPTIONS OR
6051B	1	DELINEATOR DECAL STRIPE KIT
** ANCHOR HARDWARE (FULL CONCRETE BASE)		
6945C	34	5/8" x 10" ANCHOR STUD
6352C	21	5/8" x 7 1/2" ANCHOR STUD
5448B	6	ADHESIVE HY 150 MAX (CARTRIDGE)
3300C	55	5/8" LOCKWASHER
3301C	55	5/8" WASHER
3361C	55	5/8" HEX NUT
** ANCHOR HARDWARE (ASPHALT BASE)		
6360C	55	5/8" x 18" ALL THRD ROD
5448B	12	ADHESIVE HY 150 MAX (CARTRIDGE)
3300C	55	5/8" LOCKWASHER
3300C	55	5/8" WASHER
3361C	55	5/8" HEX NUT

OPTIONAL HEART ANCHOR ITEMS

PART NUMBER	DESCRIPTION
5495B	ADHESIVE DISPENSER
5450B	MIKER HIT HY150 (NOZZLE)
5208B	FILLER HIT HY150 (FILLER TUBE)
5209B	TE-C* HY17/16-18 (17/16" BIT)

** SEE PRODUCT MANUAL
 * EACH CARTRIDGE INCLUDES 1 EACH: MIKER HY 150 CARTRIDGE (NOZZLE) FILLER HY 150 (FILLER TUBE)

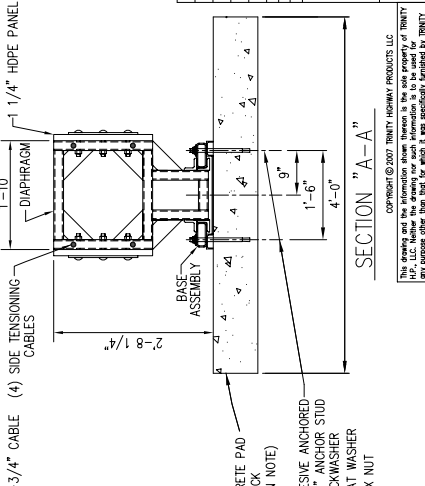
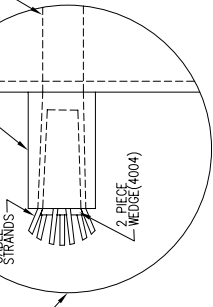

FOUNDATION NOTE:
 8" UNREINFORCED CONCRETE PAD IS SHOWN
 OTHER OPTIONS ARE :
 a) 6" THICK MINIMUM REINFORCED CONCRETE
 b) 8" MINIMUM THICK ASPHALT
 c) FOR ASPHALT OVERLAYS ON CONCRETE, CONTACT TRINITY HIGHWAY PRODUCTS, LLC.

REV	DATE	BY	CHKD	DATE	REVISIONS
1	BT	LH	11/13/08	ADDED 4 ADDITIONAL ANCHORS	

HEART

TRAIN	LH
DESIGN	B.T.
SCALE	N.T.S.
DATE	02/11/08
DOC FILE #	SS1502-01E
DRAWING	ET OF 1
DRAWING NO.	SS 1502

TRINITY HIGHWAY PRODUCTS, LLC.
 2525 STEWARTS FREEWAY
 DALLAS, TX 75207

Copyright © 2007 TRINITY HIGHWAY PRODUCTS, LLC
 All rights reserved. No part of this document may be reproduced or transmitted in any form or by any means electronic or mechanical, including photocopying, recording, or by any information storage and retrieval system, without the prior written permission of TRINITY HIGHWAY PRODUCTS, LLC. For more information, contact TRINITY HIGHWAY PRODUCTS, LLC at 2525 STEWARTS FREEWAY, DALLAS, TX 75207.

HEART TRANSITION BILL OF MATERIAL

PART NUMBER	QTY	DESCRIPTION
3056	1	12/6" x 3/4" GUARDRAIL PANEL
9756	2	10 GA. END TERMINAL
3158B	1	TAPERED WOOD BLK 1'-9" (6 x 6 1/2)
3165B	1	TAPERED WOOD BLK 1'-9" (6 x 4)
26078C	1	BENT TRANSITION PLATE
26079C	1	BARRIER ATTACHMENT TOP BRACKET
33566	4	TRANSITION SIDE BRACKET
33757C	6	CMB ANCHOR BRACKETS
* HARDWARE		
33006	16	5/8" WASHER (F844)
3310G	6	5/8" LOCKWASHER
3340C	24	5/8" HGR NUT
3360C	24	5/8" x 1 1/4" HGR SPLICE BOLT
3361G	6	5/8" HEX NUT (A563 DH)
3440C	6	5/8" x 4" HEX HD BOLT (A325)
4412C	4	5/8" x 3" LAG SCREW
3701C	30	3/4" WASHER
3704G	23	3/4" HEX NUT
3716G	7	3/4" x 2" HEX HD BOLT (A325)
4709G	8	3/4" x 4 1/4" EXPANSION ANCHOR
4711G	8	3/4" x 5 1/2" EXP. ANCHOR
* BRACKET ANCHOR HARDWARE (CONCRETE BASE)		
6352C	18	5/8" x 7 1/2" ANCHOR STUD
5446B	3	ADHESIVE HY 150 MAX (CARTRIDGE)
3310G	6	5/8" LOCKWASHER
33006	18	5/8" WASHER
3361G	18	5/8" HEX NUT
* BRACKET ANCHOR HARDWARE (ASPHALT BASE)		
6350C	6	5/8" x 18" ALL THRD ROD
6352C	12	5/8" x 7 1/2" ANCHOR STUD
5446B	4	ADHESIVE HY 150 MAX (CARTRIDGE)
3310G	6	5/8" LOCKWASHER
33006	18	5/8" WASHER
3361G	18	5/8" HEX NUT

* CONCRETE MEDIAN BARRIER BRACKETS AND HARDWARE ARE REQUIRED ONLY WHEN BARRIER IS TEMPORARY OR UNANCHORED.

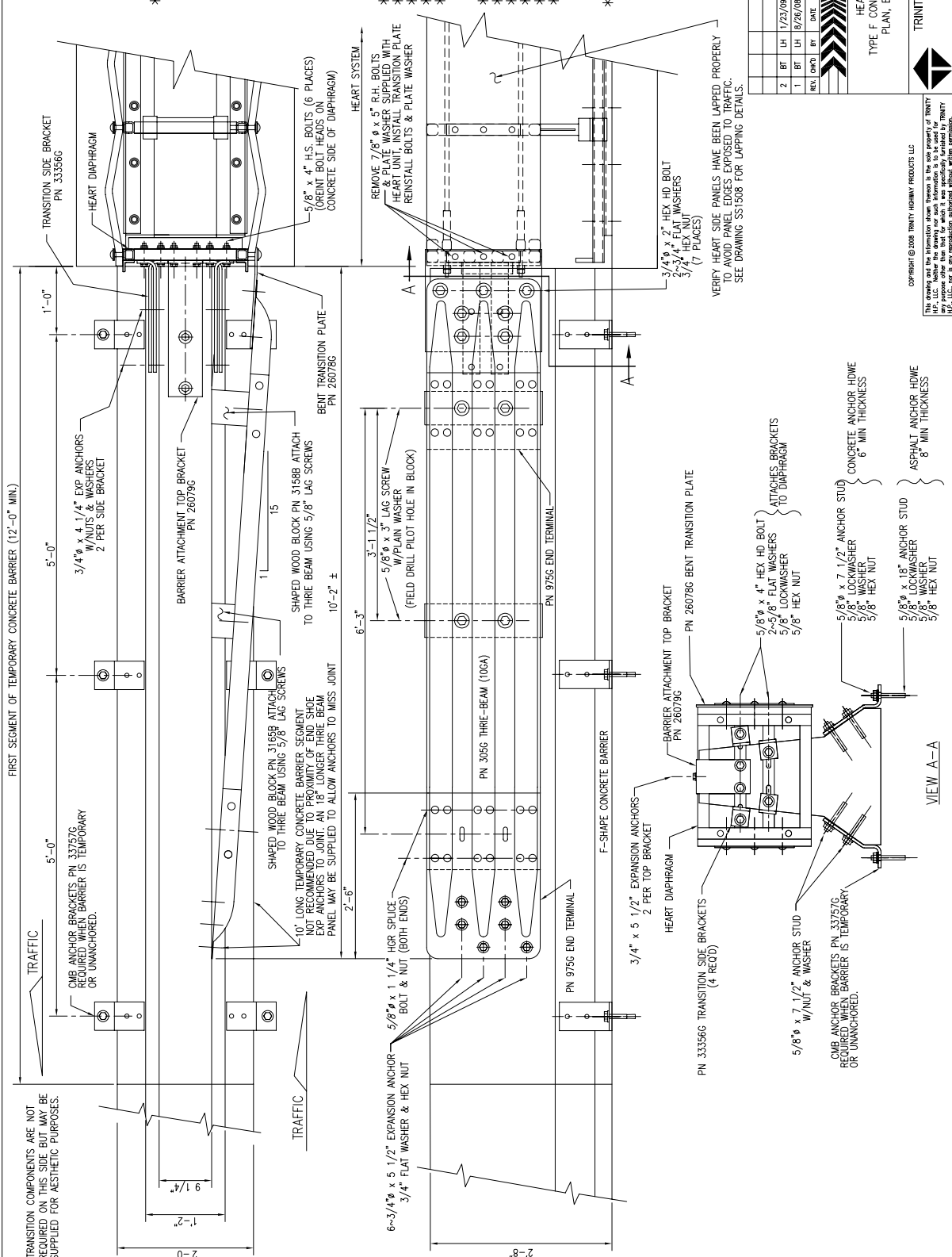

COPYRIGHT © 2008 TRINITY HIGHWAY PRODUCTS, LLC
 THE DRAWING AND THE INFORMATION SHOWN THEREON IS THE SOLE PROPERTY OF TRINITY HIGHWAY PRODUCTS, LLC. Neither the drawing nor such information is to be used for TRINITY HIGHWAY PRODUCTS, LLC, nor is any reproduction authorized without written permission.

HEART

HEART TRANSITION TO TYPE F CONCRETE MEDIAN BARRIER PLAN, ELEVATION & SECTIONS

DATE: 03/12/08
 SCALE: N.T.S.
 DRAWN: LH
 CHECKED: BT
 DATE: 03/12/08
 DATE: 03/12/08
 DATE: 03/12/08
 DATE: 03/12/08

TRINITY HIGHWAY PRODUCTS, LLC.
 2525 STEWARTS FREEWAY
 DALLAS, TX 75207

SS 1508

REV	DATE	BY	DESCRIPTION
2	1/23/09	LH	ADDED BASE ANCHOR HOWE
1	8/26/08	LH	ADDED WOOD BLOCK TO MIDDLE OF TRANSITION PANEL

HEART TRANSITION BILL OF MATERIAL		
PART NUMBER	QTY	DESCRIPTION
26079G	1	BARRIER ATTACHMENT TOP BRACKET
33356G	4	TRANSITION SIDE BRACKET
33757G	6	CMB ANCHOR BRACKETS
HARDWARE		
3300C	12	5/8" WASHER (F844)
3310G	6	5/8" LOCKWASHER
3361G	6	5/8" HEX NUT (A563 DH)
3440G	6	5/8" x 4" HEX HD BOLT (A325)
3701G	10	3/4" WASHER
3704G	10	3/4" HEX NUT
4709G	8	3/4" x 4 1/4" EXPANSION ANCHOR
4711G	2	3/4" x 5 1/2" EXP. ANCHOR
BRACKET ANCHOR HARDWARE (CONCRETE BASE)		
6352G	18	5/8" x 7 1/2" ANCHOR STUD
5448B	3	ADHESIVE HY 150 MAX (CARTRIDGE)
3310G	6	5/8" LOCKWASHER
3300C	18	5/8" WASHER
3361G	18	5/8" HEX NUT
BRACKET ANCHOR HARDWARE (ASPHALT BASE)		
6390G	6	5/8" x 18" ALL THRD ROD
6352G	12	5/8" x 7 1/2" ANCHOR STUD
5448B	4	ADHESIVE HY 150 MAX (CARTRIDGE)
3310G	6	5/8" LOCKWASHER
3300C	18	5/8" WASHER
3361G	18	5/8" HEX NUT

* CONCRETE MEDIAN BARRIER BRACKETS AND HARDWARE ARE REQUIRED ONLY WHEN BARRIER IS TEMPORARY OR UNANCHORED.

VERIFY HEART SIDE PANELS HAVE BEEN LAPPED PROPERLY TO AVOID PANEL EDGES EXPOSED TO TRAFFIC. SEE DRAWING SS1508 FOR LAPPING DETAILS

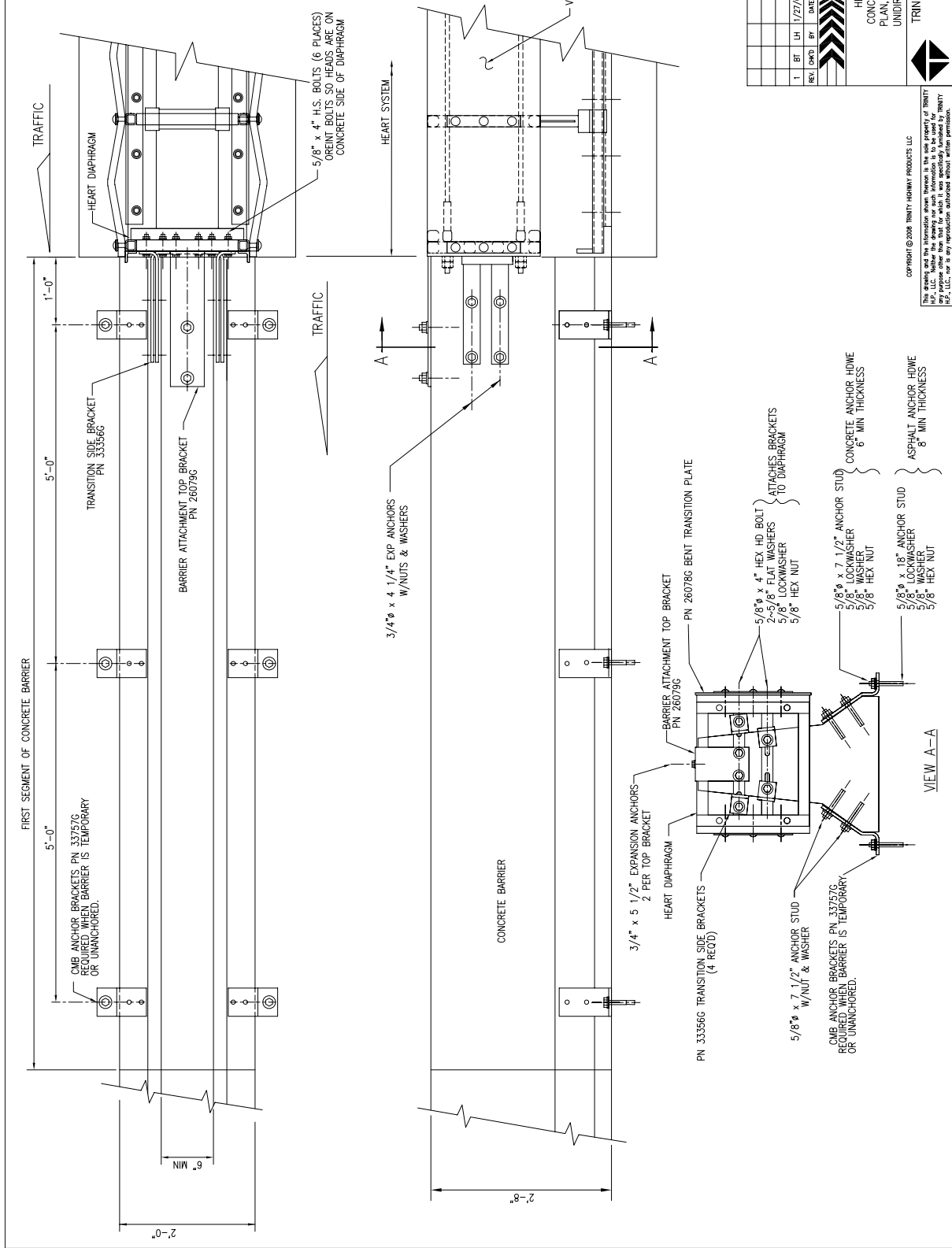

COPYRIGHT © 2008 TRINITY HIGHWAY PRODUCTS, LLC
 This drawing and the information shown herein is the sole property of TRINITY H.P., LLC. Neither the drawing nor such information is to be used for any purpose other than that for which it was specifically furnished by TRINITY H.P., LLC, and it is not to be reproduced, stored, or transmitted in any form.

REV	DATE	BY	CHKD	DESC
1	BT	UH	1/27/09	ADDED CMB ANCHOR BRACKET HOWE

HEART

HEART TRANSITION TO CONCRETE MEDIAN BARRIER PLAN, ELEVATION & SECTIONS UNIDIRECTIONAL TRAFFIC ONLY

SCALE: N.T.S.
 DATE: 03-12-08
 ENC. FILE # S5507E
 SHEETS: E1 OF 1
 DRAWING NO.: SS 1507

TRINITY HIGHWAY PRODUCTS, LLC.
 2525 STEWARTS FREEWAY
 DALLAS, TX 75207

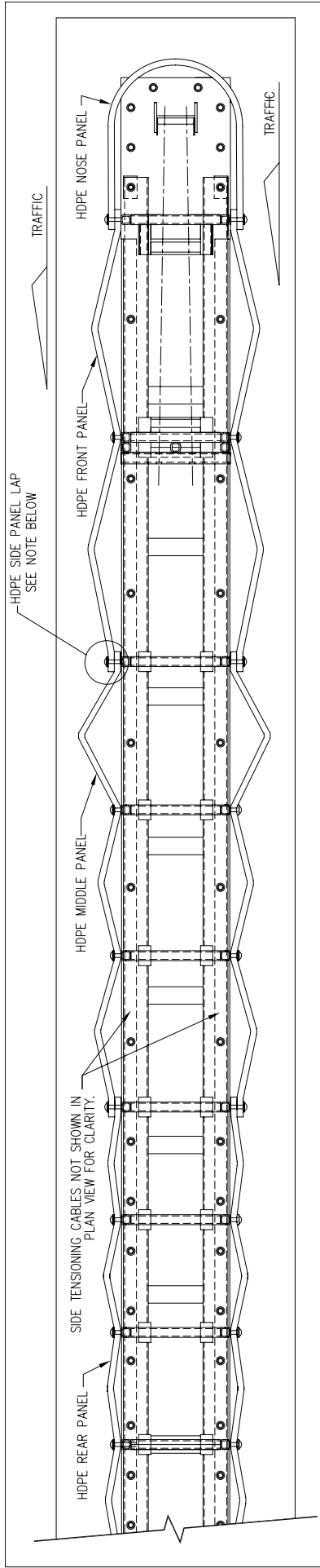

HEART CRASH CUSHION FOR UNIDIRECTIONAL TRAFFIC
 HDPE SIDE PANEL LAPPING SCHEMATIC

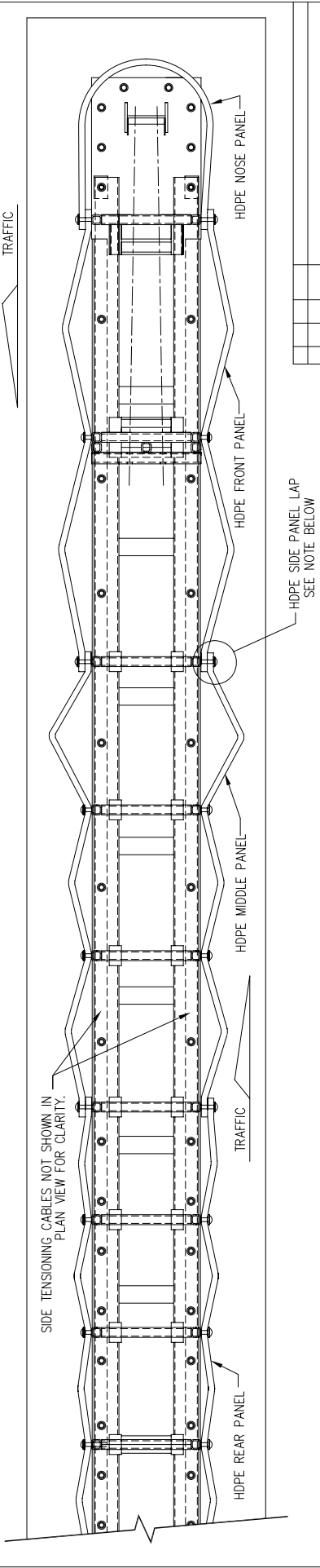

HEART CRASH CUSHION FOR BIDIRECTIONAL TRAFFIC
 HDPE SIDE PANEL LAPPING SCHEMATIC

NOTE:
 VERIFY HEART SIDE PANELS HAVE BEEN LAPPED PROPERLY
 TO AVOID PANEL EDGES EXPOSED TO TRAFFIC.

REV.	DATE	BY	CHKD.	SCALE	DATE	ENCL.	FILE #	SHR.	FRAMING NO.	REV.
										0

HEART CRASH CUSHION HYBRID ENERGY ABSORBING REUSABLE TERMINAL UNIDIRECTIONAL & BIDIRECTIONAL TRAFFIC FLOWS HDPE SIDE PANEL LAPPING SCHEMATIC	DRAWN BY: BT CHECKED BY: SC SCALE: N.T.S. DATE: 03-11-08 ENCL. FILE # S55098-01E SHR.: E1 OF 1 FRAMING NO.: SS 1508
TRINITY HIGHWAY PRODUCTS, LLC. 2525 STEWARTS FREEWAY DALLAS, TX 75207	

COPYRIGHT © 2008 TRINITY HIGHWAY PRODUCTS, LLC
 THIS DRAWING AND THE DRAWING INFORMATION IS THE PROPERTY OF TRINITY HIGHWAY PRODUCTS, LLC. NO PART OF THIS DRAWING OR THE DRAWING INFORMATION IS TO BE REPRODUCED OR TRANSMITTED IN ANY FORM OR BY ANY MEANS, ELECTRONIC OR MECHANICAL, INCLUDING PHOTOCOPYING, RECORDING, OR BY ANY INFORMATION STORAGE AND RETRIEVAL SYSTEM, WITHOUT THE WRITTEN PERMISSION OF TRINITY HIGHWAY PRODUCTS, LLC.



2525 Stemmons Freeway

Dallas, Texas 75207

888-323-6374 (USA only)

214-589-8140 (Outside USA)

www.energyabsorption.com

www.highwayguardrail.com